

Gömme rezervuar sıcak - soğuk su bağlantılarının klozet bağlantısına uygun olması için tesisatın klozete uyumlu olması önemlidir. Klozete tesisatınızın uyum kontrolünü kesinlikle yapınız, yapılmadığı takdirde montajınız olmayacaktır.

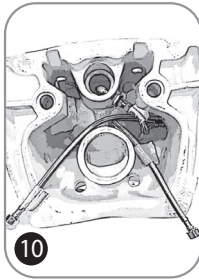
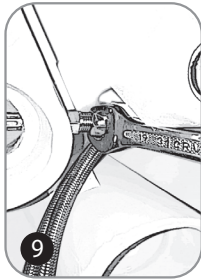

• Paket içeriğinde 1 adet entegre ara musluk, 1 adet sıcak su, 1 adet soğuk su ve 1 adette taharet bağlantı fleksisi mevcuttur. (Resim 1)

• Entegre ara musluk üzerinde bulunan 1 adet lastik conta ve 1 adet somun çevrilerek çıkarılır. (Resim 2)

• Ürün üzerinde belirtilen sıcak, soğuk ve çıkış hortumları 11 numara anahtar yardımıyla sıkılırlar. (Resim 5)

• Flexiler ürünün dışından içeriye doğru salınır ve 7 ve 8 numaralı görsellerdeki somun fleksilerin tamamınına içine alacak şekilde yerine sıkılarak sabitlenir.

• Taharet çubuğuna bağlanacak çıkış fleksisinde 19 numaralı anahtarla sıkılarak işlem sonuçlandırılır. (Resim 9)

• Yeri hazırlanıp soğuk ve sıcak su bağlantısı hazırlanmış olan tesisata montajlanmak için hazırdır. (Resim 10)

Sıcak su bağlantısı olan entegre ara musluklarda sıcak suya bağlı yanıkların olmaması için dikkat edilmelidir.

Cerastyle haber vermeksizin, ürünler ve teknik detaylarında değişiklik yapma hakkını saklı tutar. Tüm çizimler standart toleranslar dahilindedir. Montaj uygulamalarında kesin ölçü ihtiyacı olursa ürün üzerinden alınan birebir ölçüler kullanılmalıdır.

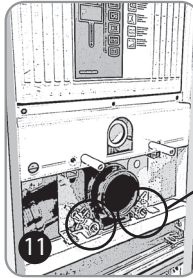
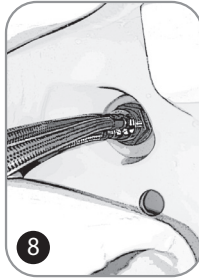
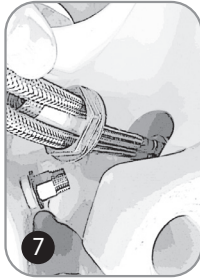
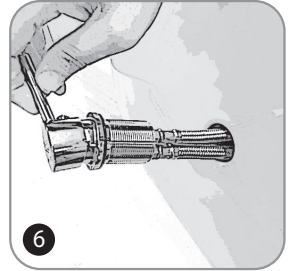
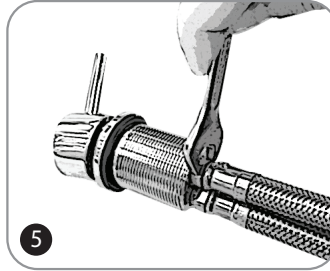
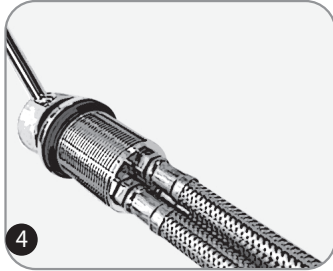
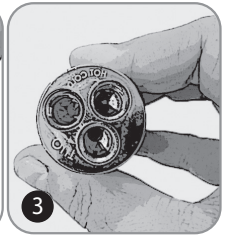
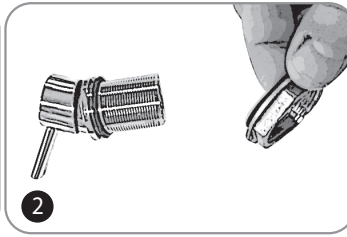
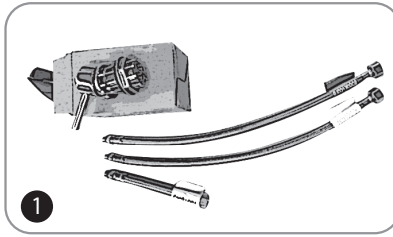

-It's essential that the plumbing should be compatible with the closet for suitable connection with the concealed cistern.

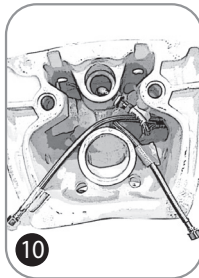
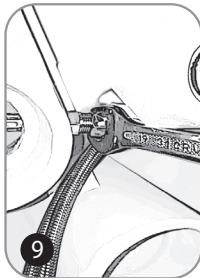

- Package contains an integrated tap, a flexy hose for hot water, a flexy hose for cold water and a flexy hose for bidet hole connection. (Picture 1)
- Remove the gasket and the nut on integrated tap. (Picture 2)
- Tighten flexy hoses with a spanner. (Picture 5)
- Collect flexy hoses together to inside of the product and fix the tap. (Picture 7 and Picture 8)
- Fix the flexy hose for bidet connection to the bidet hole with a spanner. (Picture 9)

- Product can be installed at this stage if hot and cold water connections are ready.

The versions that have hot water connection needs to be used carefully to avoid skin burns.

Cerastyle reserves the right to change products and technical details at any time without notice. All drawings are within the standard tolerances. In case of a need for exact dimensions while mounting, the dimensions on the product should be taken in consideration.



ASMA KLOZET MONTAJ TALİMATI

INSTALLATION MANUAL OF WALL HANG CLOSET

MANUEL D'INSTALLATION DU CABINET ACCROCHANT

دليل الإستخدام و إرشادات التركيب للمرحاض المعلق إبيزا

IBIZA • HERA

KAPAK MONTAJ DELİKLERİNDEN

(GİZLİ)

KLOZET MONTAJI

(HIDDEN) TOILET ASSEMBLY THROUGH
SEATCOVER MOUNTING HOLES

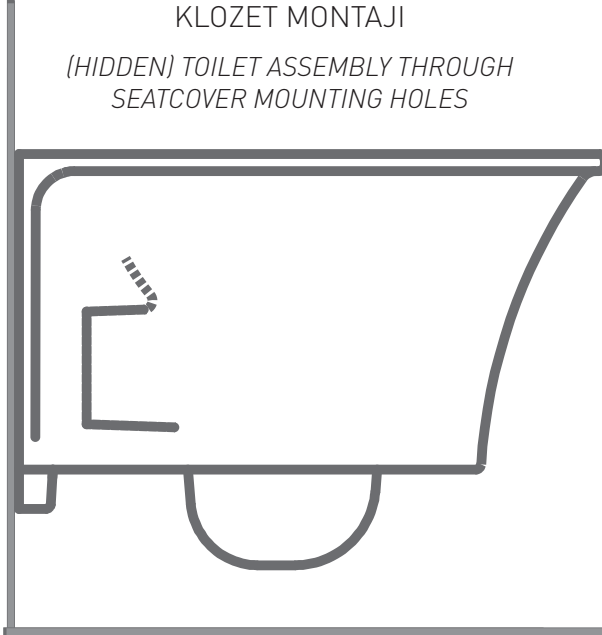

Wall hung wc installation

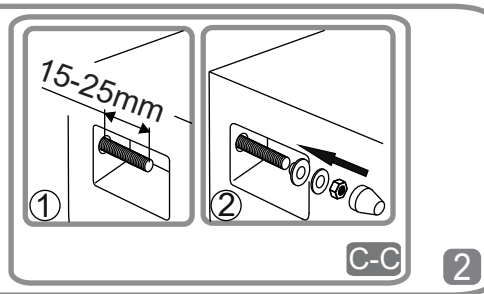
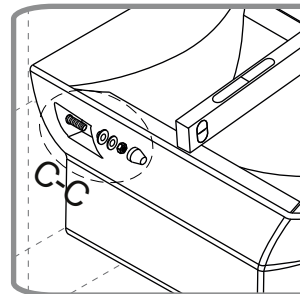
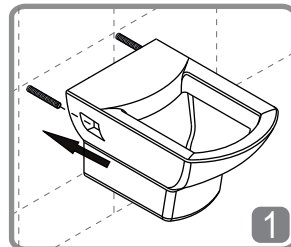
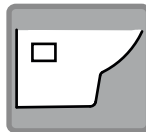
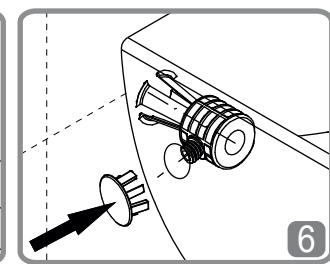
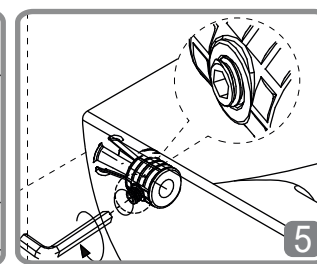
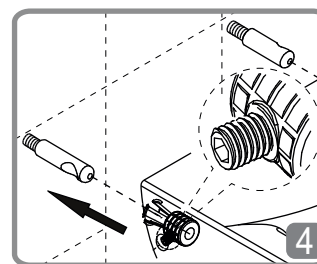
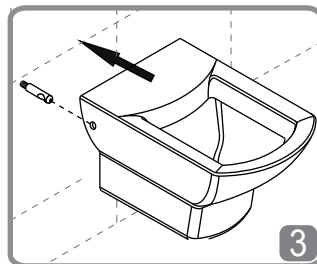
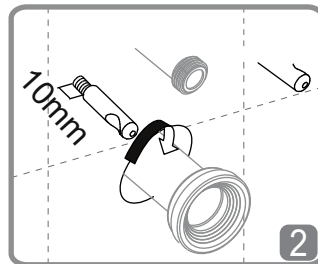
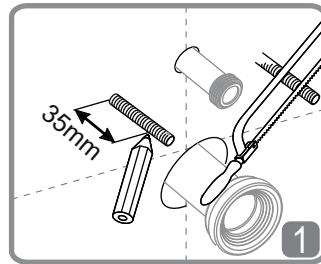
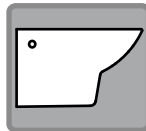
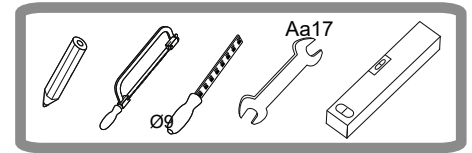
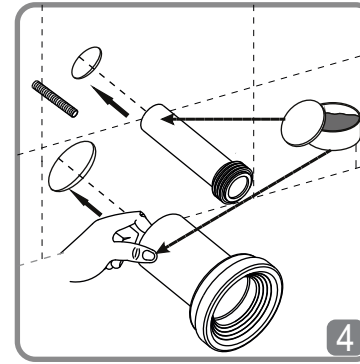
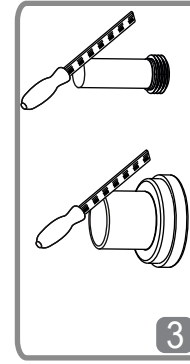
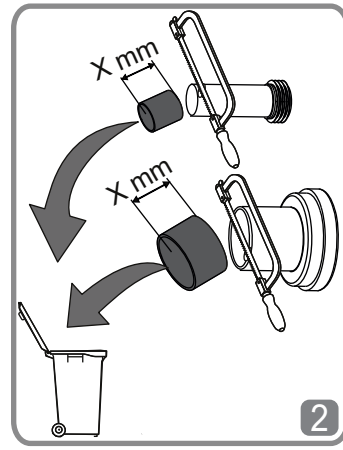
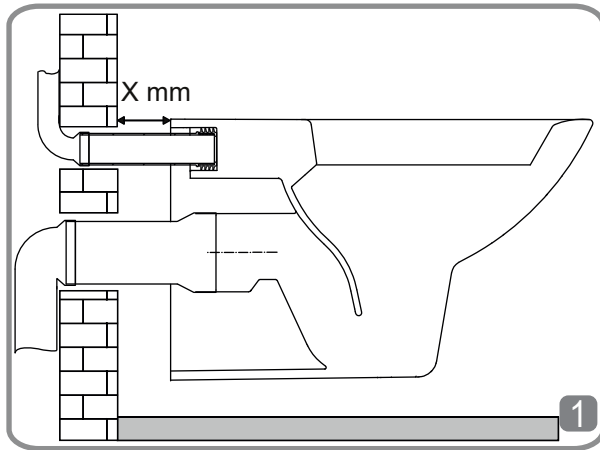

1. Montaj Elemanları

Recommended Tools and Materials

Les matériels d'installation

أدوات التثبيت

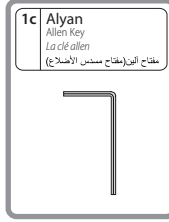

2. Montaj Öncesi Hazırlık

Preparation for Installation

Préparation pré-installation

الخطوات المتبعة قبل التركيب

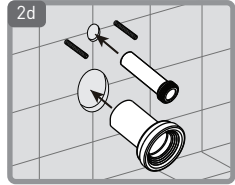
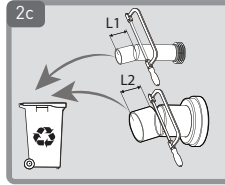
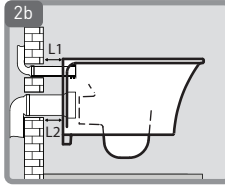
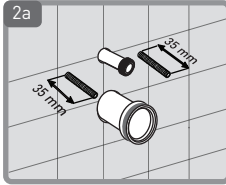

2a. Sabitleme civataları Dışarıda 35 mm kalacak şekilde bırakılmasına dikkat edilir.

Clamping screws should be adjusted to 35 mm outside of the wall.

Vis de serrage autorisés à rester à l'extérieur de 35 mm.

ضبط و تركيب مسمار التثبيت بحيث يكون الظاهر منه طوله 35 سم

2b. Asma klozet; gömme rezervuarın, temiz su borusu ve pis su gider borusu fazla kısmı kesilmek üzere gömme rezervuara şekilde görüldüğü gibi konumlandırılır ve L1/L2 mesafeleri ölçülür.

Drain pipe and clean water pipes should be adjusted to the wall like as shown on picture 2c.

Le cabinet accrochant; réservoir de rinçage, les conduites d'eau potable et des égouts coûte l'exédent est positionné comme indiqué sur la figure cachée citerne à couper et L1 / L2 la distance sont mesurés.

تركيب انابيب المياه النظيفة و العادمة و قياس المسافة الزائدة بين الحائط والمرحاض L1/L2

2c. Gömme rezervuarın, temiz su borusu ve pis su gider borusu fazla kısmı L1/L2 ölçülerinde kesilir.

More than necessary part of drain pipe and clean water pipe should be cut according to L1 and L2 dimensions.

À réservoir intégré, les conduites d'eau potable et d'égout drainage des tuyaux autant partie de la coupe L1 / L2 en taille.

قص الأجزاء الزائدة من انابيب المياه L1/L2 كما هو موضح بالشكل

2d. Gömme rezervuara, temiz su borusu ve pis su gider borusu tekrar monte edilir.

Two pipes in to the concealed cistern should be placed.

Intégré dans le réservoir, les conduites d'eau potable et les tuyaux d'évacuation des eaux usées installés à nouveau.

تثبيت الانابيب مكانها مع الخزان الداخلي، كما هو موضح بالشكل

3. Montaj Elemanlarının Asma Klozete Yerleştirilmesi

Assembling installation tools and materials to the Ibiza WC

Placer les fixations placard suspendus

تركيب ادوات التثبيت على المرحاض.

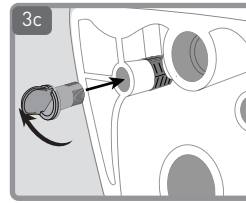
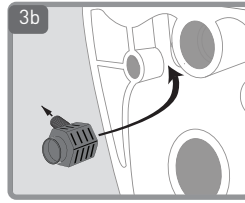
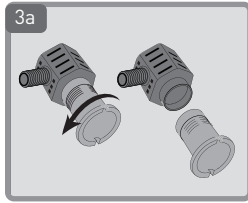

3a. Montaj elemanı şekilde görüldüğü gibi sökülür.

Disassemble the mounting bracket components as shown in figure.

Montages sont supprimés, comme indiqué sur la figure.

تفكيك قطع التثبيت عن بعضها كما هو موضح بالشكل

3b. Montaj elemanının ilgili parçası (Sarı Parçanın Yuvası) asma klozete şekilde görüldüğü gibi yerleştirilir.

Place the mounting brackets (the yellow part slot) into the closet as shown in figure .

La partie pertinente de l'élément de montage (fente partie d'enroulement) est placé comme indiqué sur la figure cabinet accrochant.

تركيب القطعة الخارجية (الجزء الأصفر) على المرحاض كما هو موضح بالشكل

***Okla gösterilen vida başının kapak montaj deliklerin karşılamasına dikkat edilmelidir.

The screws' head as shown in figure with arrow, must match with holes of mounting seat cover.

Couvrir la tête de vis de la flèche doit être envisagée pour rencontrer les trous de montage.

*** يرجى الإنتباه للأسهم على الرسم عند التركيب ، تركب القطعة باتجاه الأسهم

3c. Montaj elemanının ilgili parçaları şekilde görüldüğü gibi monte edilir. Sarı montaj elemanı yuvaya yerleştirilir ve ok yönünde sarı sıkma aparatıyla çevrilerek sabitlenir.

Place the parts of the mounting components and schrew it as shown in figures.

Les parties correspondantes de l'élément de montage est monté comme représenté sur la figure. Des éléments de montage jaunes sont placés dans la fente et en tournant la flèche jaune dispositif de serrage fixe.

يركب الجزء الثاني داخل الفتحة الموضحة وفقا لإتجاه الأسهم كما هو موضح بالشكل

4. Asma Klozet Montajı Installation Wall Hang Closet

D'installation du cabinet accrochant تركيب المرحاض

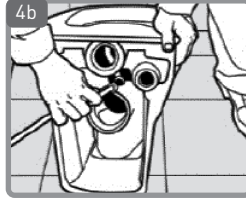
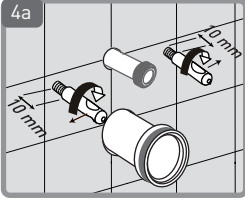
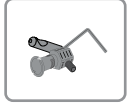

4a. Vida yuvası, gömme rezervuardaki sabit civatalara şekilde görüldüğü gibi ve ok yönünde çevrilerek montajlanır.

The union screw should be placed to the fixed bolts as shown in figure.

Fente à vis, comme représenté sur les boulons de figure fixe sur le réservoir intégré et assemblé en tournant le sens de la flèche.

تركيب غمد المسمار على المسمار مع الإنتباه لتكون فتحة الغمد للأعلى كما هو موضح بالشكل.

******* Vida yuvasının üst kısma bakması önemlidir.

It is important that the screwing place must face upwards.

Il est important de regarder la partie supérieure de la fente de la vis.

4b. Klozetteki taharet bağlantı dirseğine flexi bağlantısı yapılır.

How the bidet system should be connected.

Toilettes connexion coude dans la connexion de flexi bidet est faite.

تنبيت خرطوم الطهارة مع كوع التنبيت على المرحاض .

******* Bağlantı öncesi dirsek kontrolü klozet montajını yapan servis tarafından

kesinlikle kontrol edilmelidir. Gevşek bırakılması veya çok sıkılması (iç contayı yırtacak kadar) halinde su kaçağına sebebiyet verebilir.

Before the installation of wall hang closet to wall, back connection of the bidet system pipe must be controlled for leakage by installer.

L'accès doit être strictement contrôlé par le coude avant d'installer la portion de contrôle de placard.

Lâche ou trop fatigué pour quitter (jusqu'à déchirer le joint intérieur) peut provoquer des fuites dans l'eau.

******* يجب فحص موضع خرطوم الطهارة من قبل عامل الصيانة الذي يقوم بالتركيب بحيث

لا يكون مرخي أو مشدود كثيرا حتى لا يمزق جلدة الحماية مما يؤدي الى التسرب .

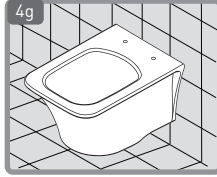
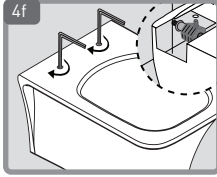
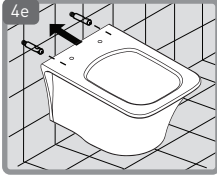
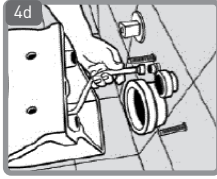
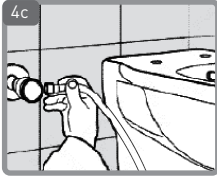

- 4c.** Taharet çubuğu flex bağlantısı açık şekilde yapılacaksa, fleksi hortumun klozetin alt kısmından geçirilerek bağlantı yapılır.

In case of bidet system's flex connection should be visible, flex hose should be positioned to the bottom of the closet as shown at figure 4c.

Si lustration doit être fait aussi clair flex lien de tige, fléchir la connexion est faite à travers le tuyau du fond du placard.

يتم تركيب خرطوم الطهارة وفقا لمصدر المياه ، إذا كان غير مخفي يجب تمرير الخرطوم

من أسفل المرحاض و ربطه بمصدر المياه الخارجي كما هو موضح بالشكل .

- 4d.** Ankastré valfli gizli montaj ile yapılacak bağlantı ise flexi temiz su girişine klozetin arkasından bağlanarak montaj tamamlanır.

In case assembling should be made with built-in valve, the flex hose should be connected to bidet system from the back side of the closet.

Construit en connectant l'ensemble de soupape qui se tiendra par placard secret dans le dos de la flexi propre ensemble d'entrée d'eau est terminée.

إذا كان المصدر مخفي يتم ربط الخرطوم مع مصدر المياه المخفي كما هو موضح بالشكل .

- 4e.** Daha sonra montaj aparatları ve kontrolleri yapılmış olan klozet duvara sıfırlanır.

After controlling all assembling parts, the wall hang closet should be fixed to the wall.

Puis remettre le placard mural monte et commandes intégrées.

بعد ذلك يتم تثبيت المرحاض بالحائط و التأكد من أن مخارج المياه مثبتة بشكل صحيح .

- 4f. Kapak montaj deliklerinden** ürün paket içeriğinde bulunan alyanlar kullanılarak gömme rezervuara sabitlemesi yapılır.

Mounting screws should be tightened with hex key (allen key) through seat cover mounting holes.

L'installation de la couverture se fait en utilisant le réservoir intégré dans la fixation de ces trous hexagonaux sur le contenu du paquet de produit.

من خلال فتحات الغطاء يتم إدخال مفتاح آلين (مفتاح مسدس الاضلاع) و يتم شد الأداة التثبيت

مع المسمار بالطريقة الموضحة بالصورة.

- 4g.** Montajı tamamlanmış ürünün kullanım öncesi montaj kaynaklı sorun olmadığı kontrol edilmelidir.

All connection points must be double checked after installation before using the closet.

L'utilisation de produits pré-assemblés doit être vérifié pour des problèmes liés à l'installation.

قبل الإستخدام يتم التأكد من أن التثبيت تم بشكل صحيح و أنه لا يوجد أي خلل

في أي جزء من أجزاء المرحاض .

CeraStyle®
S A N I T A R Y W A R E



www.cerastyle.com.tr